



Please read this manual carefully before operating your set.

Retain it for future reference.

Record model number and serial number of the set. See the label attached on the bottom of the set and quote this information to your dealer when you require service.

Model number :

Serial number :

LG DLP PROJECTOR

HS101 OWNER'S MANUAL

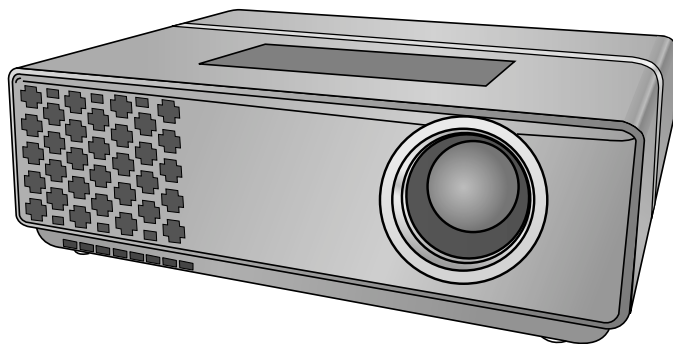

DLP PROJECTOR

FCC NOTICE

- **A Class A digital device**

This equipment has been tested and found to comply with the limits for a Class A digital device, pursuant to Part 15 of the FCC Rules. These limits are designed to provide reasonable protection against harmful interference when the equipment is operated in a commercial environment. This equipment generates, uses, and can radiate radio frequency energy and, if not installed and used in accordance with the instruction manual, may cause harmful interference to radio communications. Operation of this equipment in a residential area is likely to cause harmful interference in which case the user will be required to correct the interference at his own expense.

Warning

This is a class A product. In a domestic environment this product may cause radio interference, in which case the user may be required to take adequate measures.

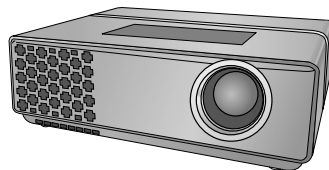

Contents

Safety Instructions	4	Special Menu Options	
Names of parts		Selecting Language	20
Main Body	7	Using ARC Function.....	20
Connecting Part	7	Flip Horizontal Function	20
Control Panel	8	Flip Vertical Function.....	21
Accessories.....	9	Using Keystone Function	21
Optional Extras	9	LED Mode Function	21
Installing and Composition		Altitude Mode Function	21
Installation Instructions	10	Screen Menu Options	
How to install the projector using the tripod ...	11	Auto Configure Function	22
Basic Operation of the Projector.....	12	Using Clock Function	22
Using Kensington Security System.....	13	Using Phase Function.....	22
Turning on the Projector	14	Using Horizontal Function.....	23
Turning off the Projector	14	Using Vertical Function	23
Focus and Position of the Screen Image.....	14	Information	
Selecting source mode	14	Supported Monitor Display.....	24
Connection		Maintenance.....	24
Connecting to a Desktop PC	15	Specifications	25
Connecting to a Notebook PC	15		
Connecting to a Video Source	15		
Connecting to a DVD	16		
Connecting to a D-TV Set-Top Box	16		
Function			
Video Menu Options			
Adjusting Video	17		
APC (Auto Picture Control).....	17		
Auto Color Temperature Control	18		
Gamma Function	18		
Black level Function	19		
Keypad Sound Function	19		
Keypad LED Function	19		

Disposal of your old appliance





1. When this crossed-out wheeled bin symbol is attached to a product it means the product is covered by the European Directive 2002/96/EC.
2. All electrical and electronic products should be disposed of separately from the municipal waste stream via designated collection facilities appointed by the government or the local authorities.
3. The correct disposal of your old appliance will help prevent potential negative consequences for the environment and human health.
4. For more detailed information about disposal of your old appliance, please contact your city office, waste disposal service or the shop where you purchased the product.

Safety Instructions

Please take note of the safety instructions to prevent any potential accident or misuse of the projector.

→ Safety Instructions are given in two forms as detailed below.

 **WARNING** : The violation of this instruction may cause serious injuries and even death.

 **NOTES** : The violation of this instruction may cause light injuries or damage to the projector.

→ After reading this manual, keep it in the place that the user always can contact easily.

Indoor Installation **WARNING**

<p>Do not place the Projector in direct sunlight or near heat sources such as radiators, fires and stove etc.</p> <p>This may cause a fire hazard !</p>	<p>Do not place inflammable materials beside the projector</p> <p>This may cause a fire hazard !</p>	<p>Do not allow children to hang on the installed projector.</p> <p>It may cause the projector to fall, causing injury or death.</p>
---	--	--

Indoor Installation **NOTES**

<p>Disconnect from the mains and remove all connections before moving.</p>	<p>Do not place the projector close to sources of steam or oil such as a humidifier.</p> <p>This may create a fire hazard or an electric shock hazard !</p>	<p>Do not place the projector where it might be exposed to dust.</p> <p>This may cause a fire hazard or damage to the unit!</p>
--	---	---

<p>When installing the projector on a table, be careful not to place it near the edge.</p> <p>This may cause the projector to fall causing serious injury to a child or adult and serious damage to the projector.</p> <p>Only use a suitable stand.</p>	<p>Only use the projector on a level and stable surface.</p> <p>It may fall and cause injury and/or damage to the unit.</p>	<p>Ensure good ventilation around the projector. The distance between the projector and the wall should be more than 20cm/8 inches.</p> <p>An excessive increase in its internal temperature may cause a fire hazard or damage to the unit!</p>
---	---	---

<p>Do not block the vents of the projector or restrict air-flow in any way.</p> <p>This would cause the internal temperature to increase and could cause a fire hazard or damage to the unit!</p>	<p>Do not place the projector directly on a carpet, rug or place where ventilation is restricted.</p> <p>This would cause its internal temperature to increase and might create a fire hazard or damage the unit.</p>	
---	---	--

Outdoor Installation **WARNING**

Do not use the projector in a damp place such as a bathroom where it is likely to get wet.

This may cause a fire or an electric shock hazard !

Power **WARNING**

<p>Earth wire should be connected.</p> <p>If the earth wire is not connected, there is a possible danger of electric shock caused by the current leakage.</p> <p>If grounding methods are not possible, a separate circuit breaker should be installed by a qualified electrician.</p> <p>Do not connect ground to telephone wires, lightning rods or gas pipe.</p>	<p>The mains plug should be inserted fully into the power outlet to avoid a fire hazard !</p> <p>This may cause a fire hazard or damage the unit.</p>	<p>Do not place heavy objects on the power cord.</p> <p>This may cause a fire or an electric shock hazard !</p>
---	---	---

Power

 WARNING

Do not use too many plugs on the Mains multi-outlet.
It may result in overheating of the outlet and causes a fire hazard !

Power

 NOTES

Never touch the power plug with a wet hand
This may cause an electric shock hazard !

Hold the plug firmly when unplugging. If you pull the cord, it may be damaged.
This may cause a fire hazard !

Prevent dust collecting on the power plug pins or outlet.
This may cause a fire hazard !

Do not plug when the power cord or the plug is damaged or any part of the power outlet is loose.
This may cause a fire or an electric shock hazard or damage to the unit!

Ensure the power cord does not come into contact with sharp or hot objects such as a heater.
This may cause a fire or an electric shock hazard or damage to the unit!

Place the projector where people will not trip or tread on the power lead.
This may cause a fire or an electric shock hazard or damage to the unit!

Do not turn the projector On/Off by plugging-in or unplugging the power plug to the wall outlet.
(Do not use the power plug for switch.)
It may cause mechanical failure or could cause an electric shock.

Using

 WARNING

Do not place anything containing liquid on top of the projector such as flowerpot, cup, cosmetics or candle.
This may cause a fire hazard or damage to the unit!

In case of impact shock or damage to the projector switch it off and unplug it from the mains outlet and contact your service center.
This may cause a fire or an electric shock hazard or damage to the unit!

Do not allow any objects to fall into the projector.
This may cause an electric shock hazard or damage to the unit!

If water is spilt into the projector unplug it from the mains supply outlet immediately and consult your Service Agent.
This may cause an electric shock hazard or damage to the unit!

In the event that an image does not appear on the screen please switch it off and unplug it from the mains supply and contact your Service Agent.
This may cause a fire or an electric shock hazard or damage to the unit!

Do not remove any covers (except lens cover). High risk of Electric Shock!

Don't look directly onto the lens when the projector is in use. Eye damage may occur!

Do not touch metal parts during or soon after operation since the vents and lamp cover will remain very hot!

CAUTION concerning the Power Cord

Most appliances recommend they be placed upon a dedicated circuit; that is, a single outlet circuit which powers only that appliance and has no additional outlets or branch circuits. Check the specification page of this owner's manual to be certain.

Do not overload wall outlets. Overloaded wall outlets, loose or damaged wall outlets, extension cords, frayed power cords, or damaged or cracked wire insulation are dangerous. Any of these conditions could result in electric shock or fire. Periodically examine the cord of your appliance, and if its appearance indicates damage or deterioration, unplug it, discontinue use of the appliance, and have the cord replaced with an exact replacement part by an authorized service personnel.

Protect the power cord from physical or mechanical abuse, such as being twisted, kinked, pinched, closed in a door, or walked upon. Pay particular attention to plugs, wall outlets, and the point where the cord exits the appliance.

Using

 WARNING

Never touch the wall outlet when there is leakage of gas, open the windows and ventilate.

It can cause a fire or a burn by a spark.

Do not drop the projector or allow impact shock.

This may cause mechanical failure or personal injury !

Don't look at laser beam directly as it can cause eye damage!

Using

 NOTES

Do not place heavy objects on top of projector.

This may cause mechanical failure or personal injury!

Take care not to impact the lens particularly when moving the projector.

Do not touch the lens of the projector. It is delicate and easily damaged.

Do not use any sharp tools on the projector as this will damage the casing.

Cleaning

 WARNING

Do not use water while cleaning the projector

This may cause damage to the projector or an electric shock hazard.

In the unlikely event of smoke or a strange smell from the projector, switch it off , unplug it from the wall outlet and contact your dealer or service centre.

This may cause a fire or an electric shock hazard or damage to the unit!

Use an air spray or soft cloth that is moist with a neutral detergent and water for removing dust or stains on the projection lens.

Cleaning

 NOTES

Contact the Service Center once a year to clean the internal parts of the projector.

Accumulated dust can cause mechanical failure.

When cleaning the plastic parts such as projector case, unplug the power and wipe it with a soft cloth. Do not use cleanser, spray water or wipe with a wet cloth. Especially, never use cleanser (glass cleaner), automobile or industrial shiner, abrasive or wax, benzene, alcohol etc., which can damage the product. Use an air spray or soft cloth that is moist with a neutral detergent and water for removing dust or stains on the projection lens.

It can cause fire, electric shock or product damage (deformation, corrosion and damage).

Others

 WARNING

Do not attempt to service the projector yourself. Contact your dealer or service centre.

This may cause damage to the projector and could give an electric Shock as well as invalidating the warranty !

Others

 NOTES

Be sure to unplug if the projector is not to be used for a long period.

Accumulated dust may cause a fire hazard or damage to the unit!

Names of parts

Main Body

* The projector is manufactured using high-precision technology. You may, however, see on the Projector screen tiny black points and/or bright points (red, blue, or green). This can be a normal result of the manufacturing process and does not always indicate a malfunction.

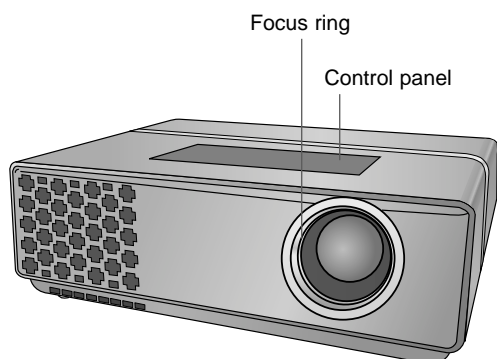

Connecting Part

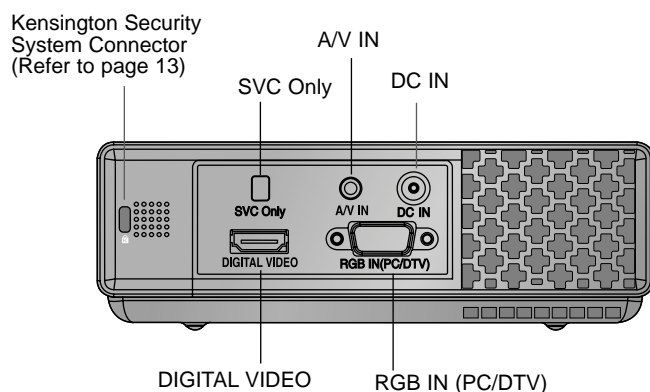

* What is the **DIGITAL VIDEO** input?

This is the input terminal to receive and display the digital video signal from the HDMI jack.

Control Panel

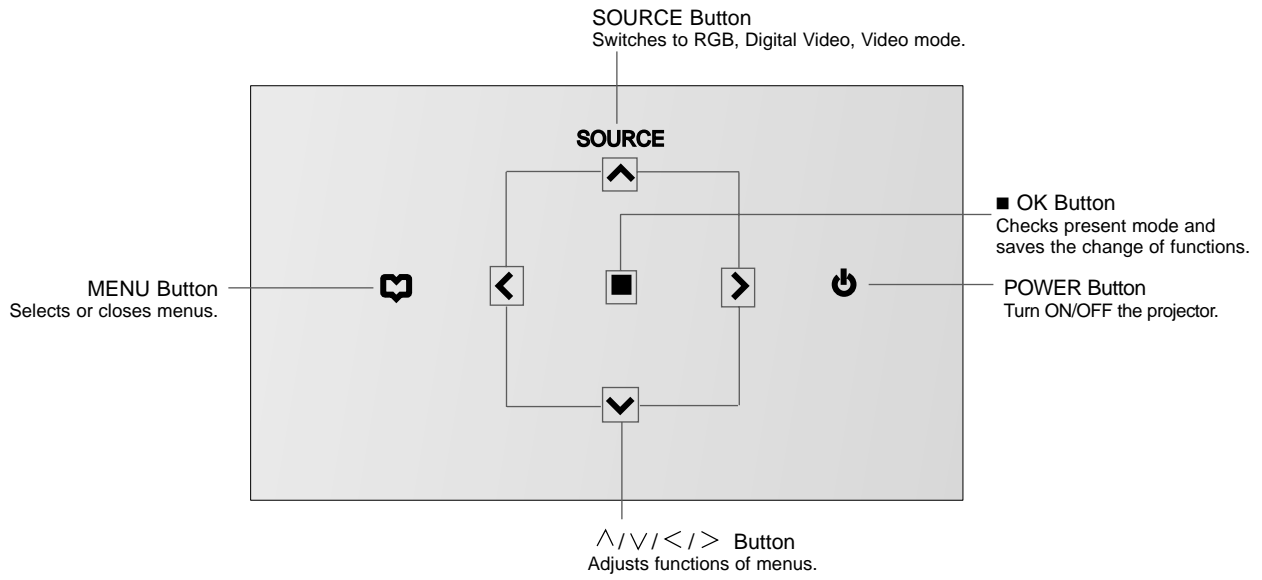

Accessories

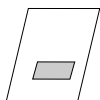

Owner's manual



CD Owner's manual



RGB to Component Cable



Polishing Cloth



Power Cord



Computer Cable



A/V Cable



Adapter

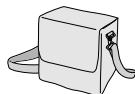

Portable bag

Optional Extras

* Contact your dealer to purchase these items.

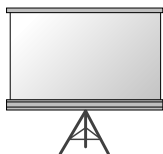

Projection Screen



HDMI Cable



Component Cable

Installing and Composition

Installation Instructions

* Don't place the projector in the following conditions. It may cause malfunction or product damage.

● Provide proper ventilation for this projector.

● The projector is equipped with ventilation holes(intake) on the bottom and ventilation holes(exhaust) on the front. Do not block or place anything near these holes, or internal heat build-up may occur, causing picture degradation or damage to the projector.

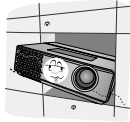

● Do not place the projector on a carpet, rug or other similar surface. It may prevent a adequate ventilation of the projector bottom. This product should be mounted to a wall or ceiling only.

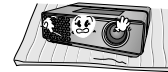

● Never push projector or spill any kind of liquid into the projector.



● Leave an adequate distance(30cm/12 inches or more) around the projector.



● In high altitude environments, set the mode to High Altitude mode before using the product.

● For locations over sea level of 1250m, it is recommended to use the High Altitude mode. (refer p.21)

● Place this projector in adequate temperature and humidity conditions.

● Install this projector only in a location where adequate temperature and humidity is available. (refer p.25)

● Don't place the projector where it can be covered with dust.

● This may cause overheating of the projector.

● Do not obstruct the slots and openings of the projector. This may cause overheating and create a fire hazard.

● The projector is manufactured using high-precision technology. You may, however, see tiny black points and/or bright points (red, blue, or green) that continuously appear on the projector Screen. This is a normal result of the manufacturing process and does not indicate a malfunction.

● To display DTV programs, it is necessary to purchase a DTV receiver (Set-top Box) and connect it to the projector.

● If there is no input signal, the Menu will not be displayed on screen.

How to install the projector using the tripod

* You can install this projector using a tripod for the camera. You can assemble the projector instead of the camera on camera tripod.

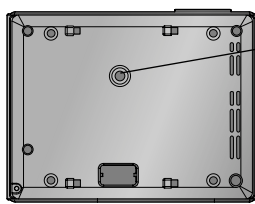

Bottom side of Projector

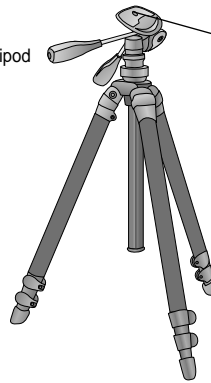

Camera Tripod

- If you have a camera tripod, assemble the projector to the part connecting to the camera tripod

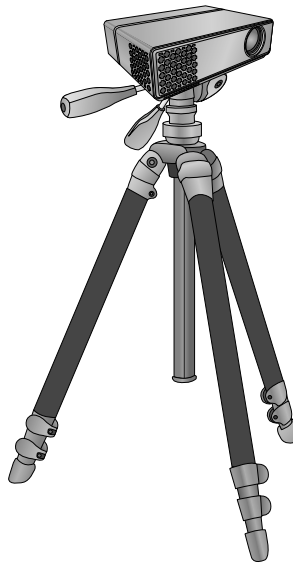

Finished condition when projector is install on the tripod

Basic Operation of the Projector

1. Place the projector on a sturdy and horizontal surface with the PC or AV source.
2. Place the projector with the desired distance from the screen. The distance between the projector and the screen determines the actual size of the image.
3. Position the projector so that the lens is set at a right angle to the screen. If the projector is not set at a right angle, the screen image will be crooked. If this is so then the keystone adjustment may correct this (Refer to page 21.).
4. Connect the cables of the projector to a wall power socket and other connected sources.

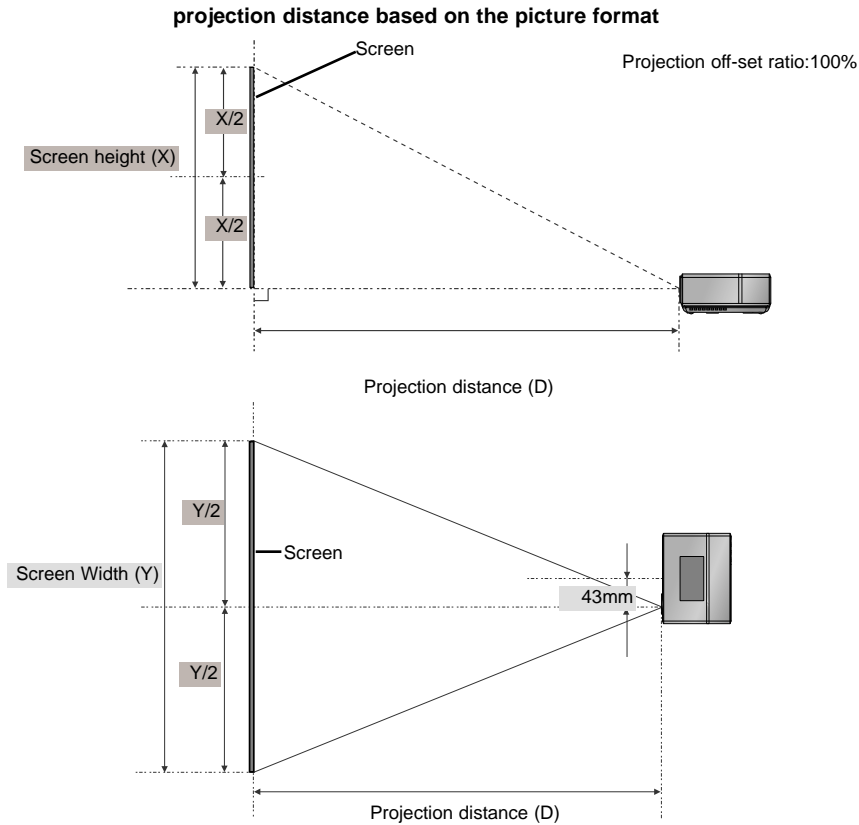



4 : 3 Scale				
Diagonal Size (inch)	Diagonal Size (mm)	Horizontal Size (mm)	Vertical Size (mm)	Projection Distance(D) (mm)
15	381	305	229	406
20	508	406	305	546
25	635	508	381	686
30	762	610	457	827
35	889	711	533	967
40	1016	813	610	1107
45	1143	914	686	1247
50	1270	1016	762	1386
55	1397	1118	838	1528
60	1524	1219	914	1668
65	1651	1321	991	1807
70	1778	1422	1067	1948
75	1905	1524	1143	2088
80	2032	1626	1219	2228

Using Kensington Security System

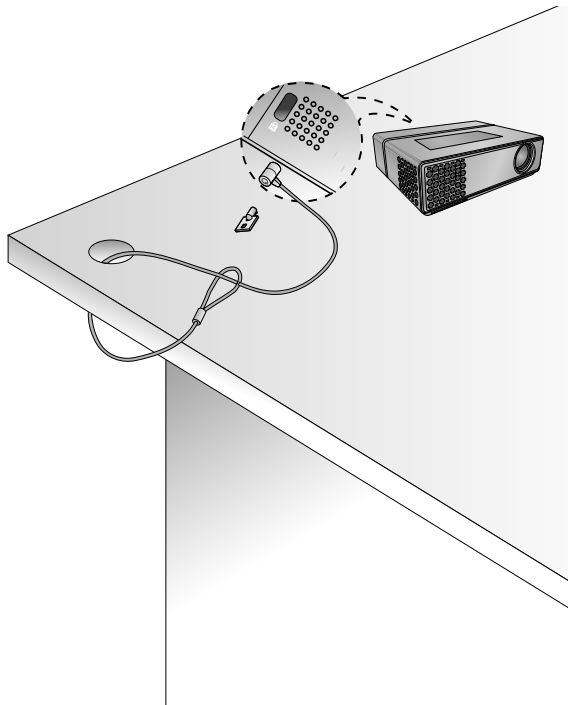

- The projector has a 'Kensington' Security System Connector on the back panel. Connect the 'Kensington' Security System cable as below.
- For the detailed installation and use of the Kensington Security System, refer to the user's guide attached to the Kensington Security System set. And for further information, contact <http://www.kensington.com>, the internet homepage of the Kensington company that deals with expensive electronic equipment such as notebook PCs or projectors.
- Kensington Security System is an optional item.



Turning on the Projector

1. Connect power cord correctly.
2. Press the **POWER** button() on the Control panel. (The light on the control panel will be turned on.)
 - Use the SOURCE button on the control panel to select the input signal you want.
 - When you press the POWER button() on the control panel when you turn on the projector, the lights for all buttons on the control panel will be turned on.

Turning off the Projector

1. Press the **POWER** button() on the Control panel.
2. Press the **POWER** button() on the Control panel again to turn off the power.
 - When you press the POWER button() on the control panel when you turn off the projector, the lights for all the buttons on the control panel will be turned off. When you press any button on the control panel when the projector is turned off, the light only on the POWER LED will be turned on. (When the Power cord is connected.)

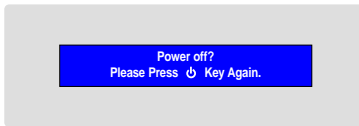

Focus and Position of the Screen Image

When an image appears on the screen, check if it is in focus and fits well to the screen.

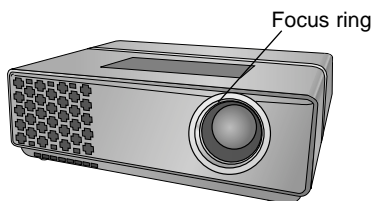



- To adjust the focus of the image, rotate the focus ring which is the outer ring on the lens.

Selecting source mode

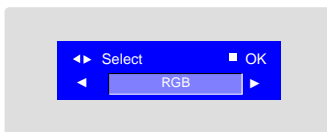
1. Press the **SOURCE** button.



2. Each press of the  ,  button changes the display as below.

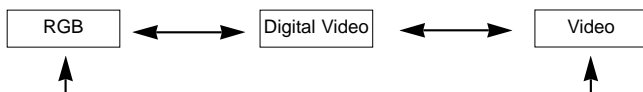

- When you connect the RGB to Component cable to the RGB IN (PC/DTV) terminal and select RGB input, you can receive the Component input.
- Digital video is the signal to receive and display the digital video signal through the HDMI jack.

Connection

Connecting to a Desktop PC

- * You can connect the projector to a computer of VGA, SVGA, XGA and SXGA output.
- * Refer to page 24 for the supported monitor displays of the projector.

< How to connect >

Connect computer cable to **RGB IN (PC/DTV)** of the projector.

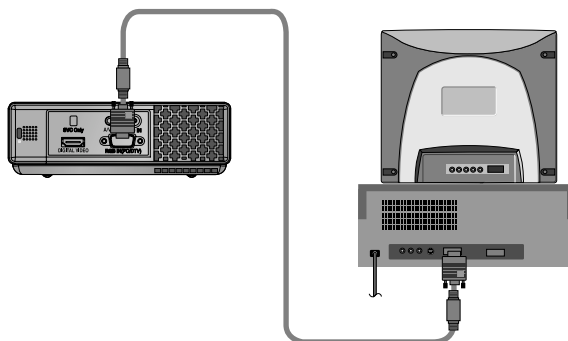

Connecting to a Notebook PC

< How to connect >

Connect computer cable to **RGB IN (PC/DTV)** of the projector.

- * If you set your computer to output the signal to both the display of your computer and the external projector, the picture of the external projector may not appear properly. In such cases, set the output mode of your computer to output the signal only to the external projector. For details, refer to the operating instructions supplied with your computer.

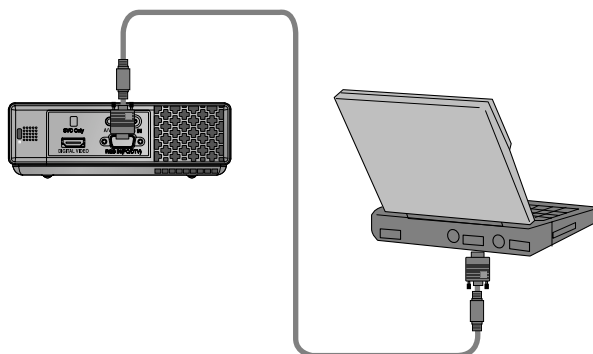

Connecting to a Video Source

- * You can connect a VTR, a camcorder or any other compatible video image source to the projector.

< How to connect >

- Connect the **A/V IN** jack of the projector to the output jacks of the A/V source with A/V cable.

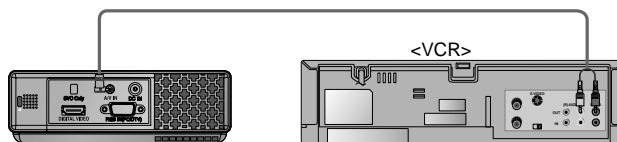

Connecting to a DVD

* The output jacks (Y, P_B, P_R) of the DVD might be labelled as Y, Pb, Pr / Y, B-Y, R-Y / Y, Cb, Cr according to the equipment.

< How to connect >

a. After connecting the Component cable of DVD to the RGB to Component cable, connect it to the **RGB IN(PC/DTV)** terminal of the projector.

* When connecting the component cable, match the jack colors with the component cable.(Y=green, P_B=blue, P_R=red)

b. You can set the Digital video mode only when there is a HDMI terminal in the DVD device.

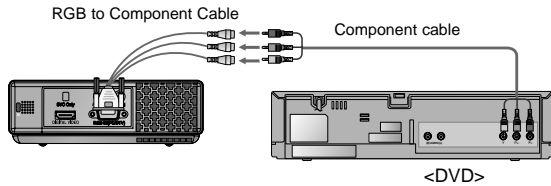

Signal	Component	RGB/DTV	HDMI/DVI
480i	O	X	X
480p	O	O	O
720p	O	O	O
1080i	O	O	O
576i	O	X	X
576p	O	O	O

Connecting to a D-TV Set-Top Box

* To receive D-TV programmes, it is necessary to purchase a D-TV receiver (Set-Top Box) and connect it to the projector.

* Please refer to the owner's manual of the D-TV Set-Top Box for the connection between projector and D-TV Set-Top Box.

< How to connect an RGB source >

a. Connect RGB cable to **RGB IN (PC/DTV)** of the projector.

* When it is connected to the D-TV Set-top box with DVI output, you can watch at the Digital Video mode by using the DVI to HDMI cable.

b. Use a DTV receiver with DTV 480p(576p)/720p/1080i mode.

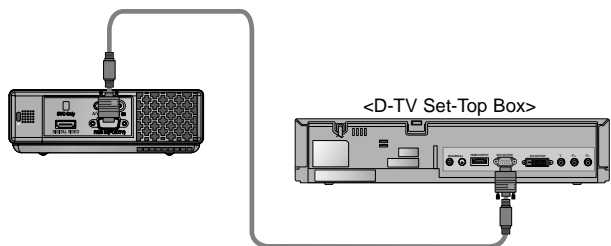

< How to connect a Digital Video source >

a. Connect the **DIGITAL VIDEO** terminal of the projector to the **HDMI** output terminal of the D-TV Set-Top Box via HDMI cable.

b. Use a DTV receiver with DTV 480p(576p)/720p/1080i mode.

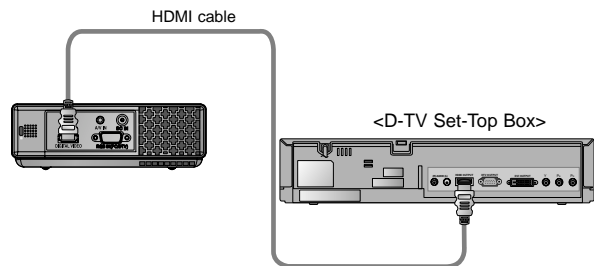

< How to connect a Component source >

a. Connect the D-TV Set-Top Box Component cable with RGB to Component cable and then connect it to **RGB IN(PC/DTV)** of the projector.

* When connecting the component cable, match the jack colors with the component cable.(Y=green, P_B=blue, P_R=red)

b. Use a DTV receiver with DTV 480p(576p)/720p/1080i mode.

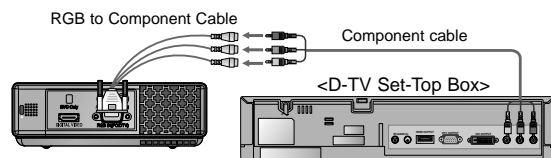

Function



* In this manual, the OSD(On Screen Display) may be different from your Projector's because it is just an example to help with the Projector operation.



* If there is no input signal present, the Menu will not be displayed.

* This operating guide explains operation of RGB(PC) mode mainly.

Video Menu Options

Adjusting Video

1. Press the **MENU** button() and then use **◀, ▶** button to select the  menu.
2. Press the **▲, ▼** button to select a video item you want to adjust.
3. Press the **◀, ▶** button to adjust the screen condition as you want.

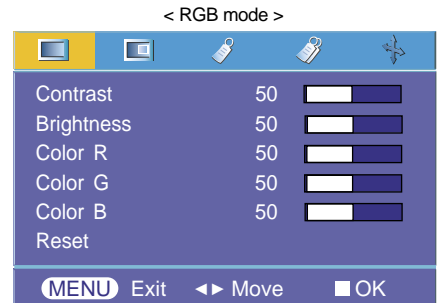

- Each adjustment of  menu options will not affect other inputs. As required, re-adjust  menu options for the following input source : Video/Component (480i(576i)), Component (480p(576p), 720p, 1080i)
- To restore the original image condition after changing it, press **■OK** button after selecting [**Reset**] item.
- When receiving an NTSC signal, the picture item **Tint** is displayed and can be adjusted.(60Hz only)
- To exit the menu display, repeatedly press the **MENU** button().



APC (Auto Picture Control)

* Use APC to set the projector for the best picture appearance.

* This function will not work at the RGB mode and the Digital video mode.

1. Press the **MENU** button() and then use **◀, ▶** button to select the  menu.
2. Press the **▲, ▼** button to select **APC** item.
3. Press the **◀, ▶** button to adjust the screen condition as you want.

- Each press of the **▲, ▼** button changes the screen as shown below.

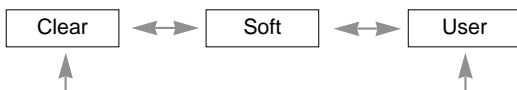

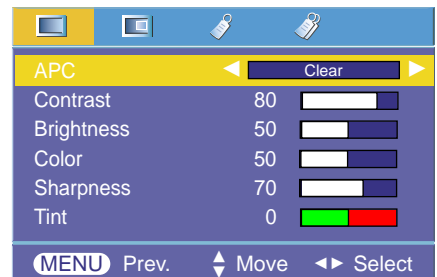

- To exit the menu display, repeatedly press the **MENU** button().



Auto Color Temperature Control

- To initialize values (reset to default settings), select the **Normal** option.

1. Press the **MENU** () button and then use **◀, ▶** button to select the  menu.
2. Press the **▲, ▼** button to select **ACC** item.
3. Press the **◀, ▶** button to make desired adjustments.

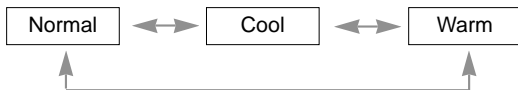

- Each press of the **◀, ▶** button changes the screen as shown below.

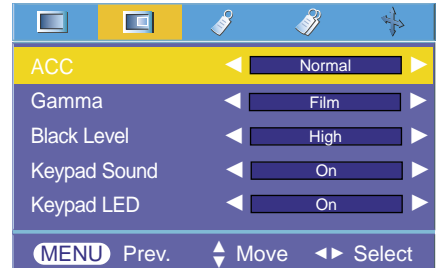

- To exit the menu display, repeatedly press the **MENU** button().



Gamma Function

1. Press the **MENU** button() and then use **◀, ▶** button to select the  menu.
2. Press the **▲, ▼** button to select **Gamma** item.
3. Press the **◀, ▶** button to adjust the screen condition as required.



- Each press of the **▲, ▼** button changes the screen as shown below.

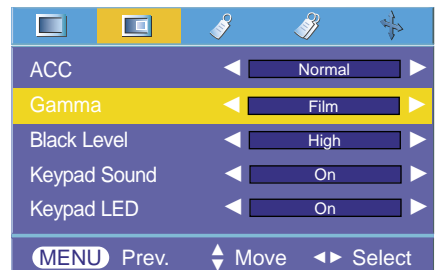

- To exit the menu display, repeatedly press the **MENU** button().



Black level Function

1. Press the **MENU** button() and then use **◀, ▶** button to select the  menu.
2. Press the **▲, ▼** button to select **Black level** item.
3. Press the **◀, ▶** button to select Low or High.



- This function works in the following mode : Digital Video
- To exit the menu display, repeatedly press the **MENU** button().
- The menu is activate/deactivate depending on the DVD setting status.
Black level function is activated only when the format is set to 4:4:4 or 4:2:2 among the set value of DVD device.

* What is the **Black level** function?

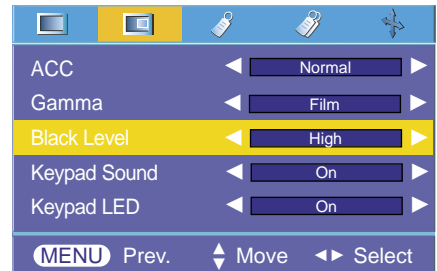
When you watch the movie, this function adjusts the set to the best picture appearance. Adjusting the contrast and the brightness of the screen using the black level of the screen.





Keypad Sound Function

1. Press the **MENU** button() and then use **◀, ▶** button to select the  menu.
2. Press the **▲, ▼** button to select **Keypad Sound** item.
3. Press the **◀, ▶** button to select On or Off.

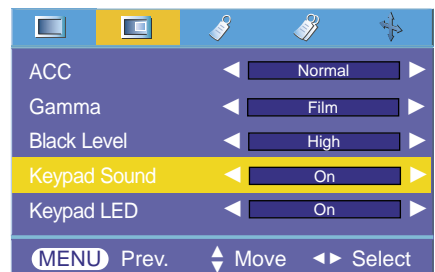
- To exit the menu display, repeatedly press the **MENU** button().



Keypad LED Function

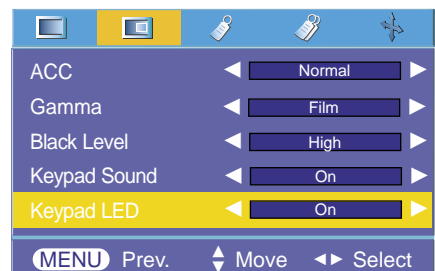

1. Press the **MENU** button() and then use **◀, ▶** button to select the  menu.
2. Press the **▲, ▼** button to select **Keypad LED** item.
3. Press the **◀, ▶** button to select On or Off.

- To exit the menu display, repeatedly press the **MENU** button().





Special Menu Options

Selecting Language

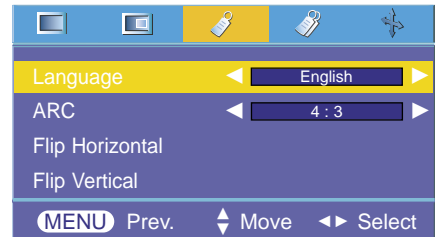
1. Press the **MENU** button() and then use **◀, ▶** button to select the  menu.
2. Press the **▲, ▼** button to select **Language** item.
3. Press the **◀, ▶** button to select the language you want to use.
 - On-Screen-Display (OSD) is displayed in the selected language.
 - To exit the menu display, repeatedly press the **MENU** button().



Using ARC Function

1. Press the **MENU** button() and then use **◀, ▶** button to select the  menu.
2. Press the **▲, ▼** button to select **ARC** item.
3. Press the **◀, ▶** button to select the screen size you want to use.



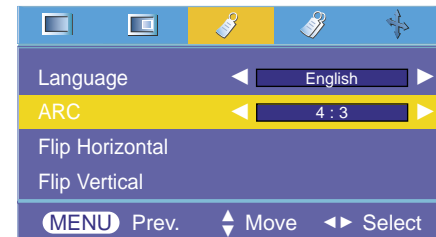

- To exit the menu display, repeatedly press the **MENU** button().



Flip Horizontal Function

* This function reverses the projected image horizontally. Use this function when rear projecting an image.

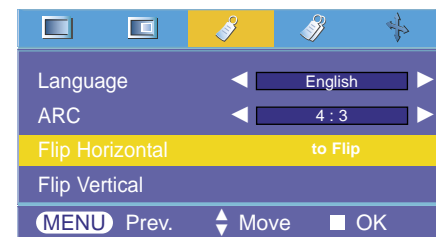

1. Press the **MENU** button() and then use **◀, ▶** button to select the  menu.
2. Press the **▲, ▼** button to select **Flip Horizontal** item.
3. Press the **■OK** button to see reversed image.

- Each time you press the **■OK** button, the image will be reversed.
- To exit the menu display, repeatedly press the **MENU** button().



Flip Vertical Function

- * This function reverses the projected image vertically.
- * When you hang the projector upside down from the ceiling , you will need to reverse the image vertically and horizontally.

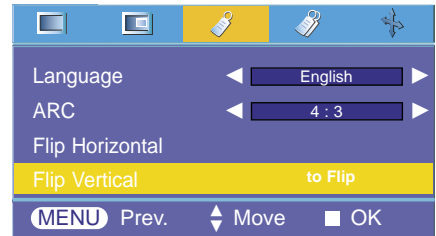

1. Press the **MENU** button() and then use **◀, ▶** button to select the  menu.
2. Press the **▲, ▼** button to select **Flip Vertical** item.
3. Press the **■OK** button to see reversed image.

- Each time you press the **■OK** button, the image will be reversed.
- To exit the menu display, repeatedly press the **MENU** button().



Using Keystone Function



- * Use this function when the screen is not at a right angle to the projector and the image is a trapezoid shape.
- * Only use the **Keystone** function when you can't get the best angle of projection.

1. Press the **MENU** button() and then use **◀, ▶** button to select the  menu.
2. Press the **▲, ▼** button to select **Keystone** item.
3. Press the **◀, ▶** button to make desired adjustments.

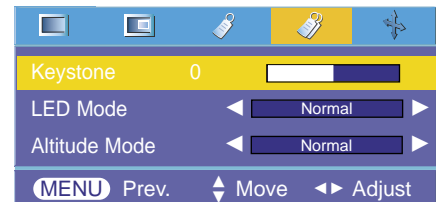
- **Keystone** can be adjusted from -50 to +50.
- To exit the menu display, repeatedly press the **MENU** button().





LED Mode Function

1. Press the **MENU** button() and then use **◀, ▶** button to select the  menu.
2. Press the **▲, ▼** button to select **LED Mode** item.
3. Press the **◀, ▶** button to select **Normal** or **Dark**.

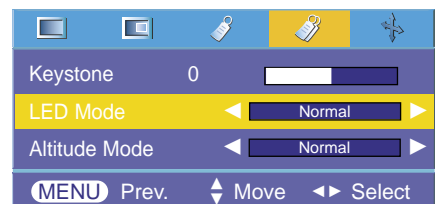
- To exit the menu display, repeatedly press the **MENU** button().



Altitude Mode Function

1. Press the **MENU** button() and then use **◀, ▶** button to select the  menu.
2. Press the **▲, ▼** button to select **Altitude Mode** item.
3. Press the **◀, ▶** button to select **Normal** or **High**.

- For locations over sea level of 1250m, it is recommended to use the High Altitude Mode.
- When you use the projector in High Altitude Mode, the fan speed becomes faster to increase the performance of the cooling system, which can increase the noise level.
- To exit the menu display, repeatedly press the **MENU** button().

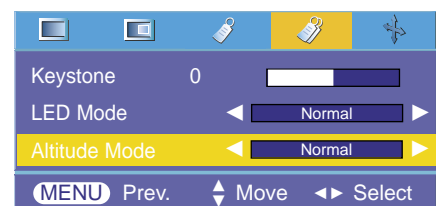





Screen Menu Options

Auto Configure Function



* This function assures you of getting the best video quality by automatically adjusting the horizontal size and synchronization of the image.

* Auto Tracking function works in RGB PC input only.

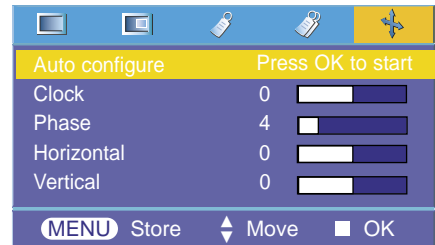
1. Press the **MENU** button() and then use **◀, ▶** button to select the  menu.
2. Press the **▲, ▼** button to select **Auto configure** item.
3. Press the **■OK** button.
 - Image positioning and synchronization are automatically adjusted.
4. If any more manual adjustment is needed according to the various PC mode inputs even after the auto-correction, execute **Clock, Phase, Horizontal** and **Vertical** function in  menu. In certain circumstances, you can't get the best picture quality by only using auto-correction.
 - To exit the menu display, repeatedly press the **MENU** button().



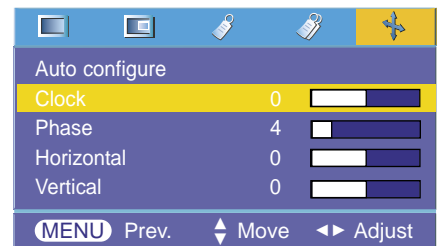

Using Clock Function

1. Press the **MENU** button() and then use **◀, ▶** button to select the  menu.
2. Press the **▲, ▼** button to select **Clock** item.
3. Press the **◀, ▶** button to make desired adjustments.
 - **Clock** adjustment range is -25 ~ +25.
 - To exit the menu display, repeatedly press the **MENU** button().
 - The variable range can be different depends on input resolutions.



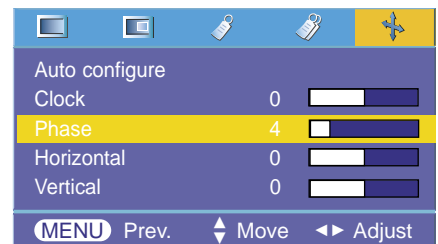

Using Phase Function

1. Press the **MENU** button() and then use **◀, ▶** button to select the  menu.
2. Press the **▲, ▼** button to select **Phase** item.
3. Press the **◀, ▶** button to make desired adjustments.
 - **Phase** adjustment range is 0 ~ 31.
 - To exit the menu display, repeatedly press the **MENU** button().
 - The variable range can be different depends on input resolutions.





Using Horizontal Function

1. Press the **MENU** button() and then use **▲**, **▼** button to select the  menu.
2. Press the **▲**, **▼** button to select **Horizontal** item.
3. Press the **◀**, **▶** button to make desired adjustments.

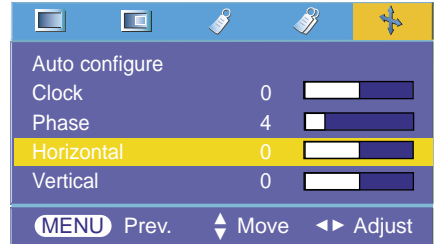
- **Horizontal** adjustment range is -50 ~ +50.
- To exit the menu display, repeatedly press the **MENU** button().
- The variable range can be different depends on input resolutions.



Using Vertical Function

1. Press the **MENU** button() and then use **▲**, **▼** button to select the  menu.
2. Press the **▲**, **▼** button to select **Vertical** item.
3. Press the **◀**, **▶** button to make desired adjustments.

- **Vertical** adjustment range is -50 ~ +50.
- To exit the menu display, repeatedly press the **MENU** button().
- The variable range can be different depends on input resolutions.

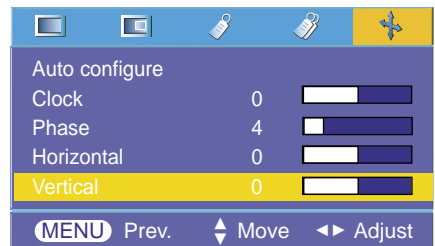

Supported Monitor Display

* The following table lists the display formats supported by the projector.

Sources	Format	Vertical Freq.(Hz)	Horizontal Freq.(kHz)
VGAEGA	640X350	70.090	31.468
	640X350	85.080	37.861
PC98	640X400	70.090	31.468
	640X400	85.080	37.861
	720X400	70.082	31.469
	720X400	85.039	37.927
VGA	640X480	59.940	31.469
	640X480	72.800	37.861
	640X480	75.000	37.500
	640X480	85.008	43.269
SVGA	800X600	56.250	35.156
	800X600	60.317	37.879
	800X600	72.188	48.077
	800X600	75.000	46.875
	800X600	85.061	53.674
XGA	1024X768	60.004	48.363
	1024X768	70.069	56.476
	1024X768	75.029	60.023
	1024X768	84.997	68.677
SXGA	1152X864	60.053	54.348
	1152X864	70.016	63.995
	1152X864	75.000	67.500
	1280X960	60.000	60.000
	1280X1024	60.020	63.981

* If the projector does not support the input signal, "Out of Range" message appears on the screen.

* The projector supports DDC1/2B type as Plug & Play function. (Auto recognition of PC monitor)

* The Synchronization input form for horizontal and vertical frequencies are Separate.

* According to PC, the optimum vertical frequency may not be displayed up to the optimum frequency of set in 'Registration information (Display registration information)'. (ex, The optimum vertical frequency may be displayed up to 85Hz or under in the resolution of 640X480 or 800X600.)

* In case of the use of HDMI to HDMI cable, PC shall not be supported.

<DVD/DTV Input>

Signal	Component-*1	RGB(DTV)-*2	HDMI(DTV)-*3
NTSC(60Hz)	480i	O	X
	480p	O	O
	720p	O	O
	1080i	O	O
PAL(50Hz)	576i	O	X
	576p	O	O
	720p	O	O
	1080i	O	O

* Cable type

1- RGB to Component Cable

2- Computer Cable

3- HDMI Cable

* Recommended 720p for a better image.

Maintenance

* The projector needs little maintenance. You should keep the lens clean because any dirt or stains may appear on the screen. If any parts need to be replaced, contact your dealer. When cleaning any part of the projector, always turn the power off and unplug the projector first.

Cleaning the lens

If there is any dust or stain on the surface of the lens, you must always clean the lens. Use an air spray or cleaning cloth for product exterior, provided with the product, to lightly clean the product. When you want to remove dust or stain on the lens, use the air spray or cloth for product exterior, provided with the product, with neutral detergent and water.

Cleaning the Projector Case

To clean the projector case, first unplug the power cable. To remove dirt or dust, wipe the casing with polish cloth provided. When you want to remove the dust or stain on the lens, use the cloth for product exterior, provided with the product.

Do not use alcohol, benzene, thinners or other chemical detergents as these can cause the casing to be warped or discolored.

Specifications

MODEL	HS101 (HS101-JE)
Resolution	800(Horizontal) x 600(Vertical)pixel
Horizontal / Vertical Ratio	4:3(horizontal:vertical)
DLP panel size	0.55 inches
Screen size (Projection distance)	0.40 ~ 2.23m(15 ~ 80 inches)
Projection OFF SET	100%
Video compatibility	NTSC/PAL/SECAM/NTSC4.43/PAL-M/PAL-N
Power	19V  , 4.74A
AC-DC Adapter	Lite-on, PA-1900-08
Height(mm/inches)	50/2.0
Breadth(mm/inches)	154/6.1
Length(mm/inches)	117/4.6
Weight(g/pound)	750/1.65

Operating Condition

Temperature

In operation : 32~95°F(0°C~35°C)
In storage and transit : -4~140°F(-20°C~60°C)

Humidity

In operation : 0~ 75% relative humidity by dry hygrometer
Not in operation : 0 ~ 85% relative humidity by dry hygrometer

